

Gough's
Garden Architecture
SEAT / BENCH
CONSTRUCTION INSTRUCTIONS

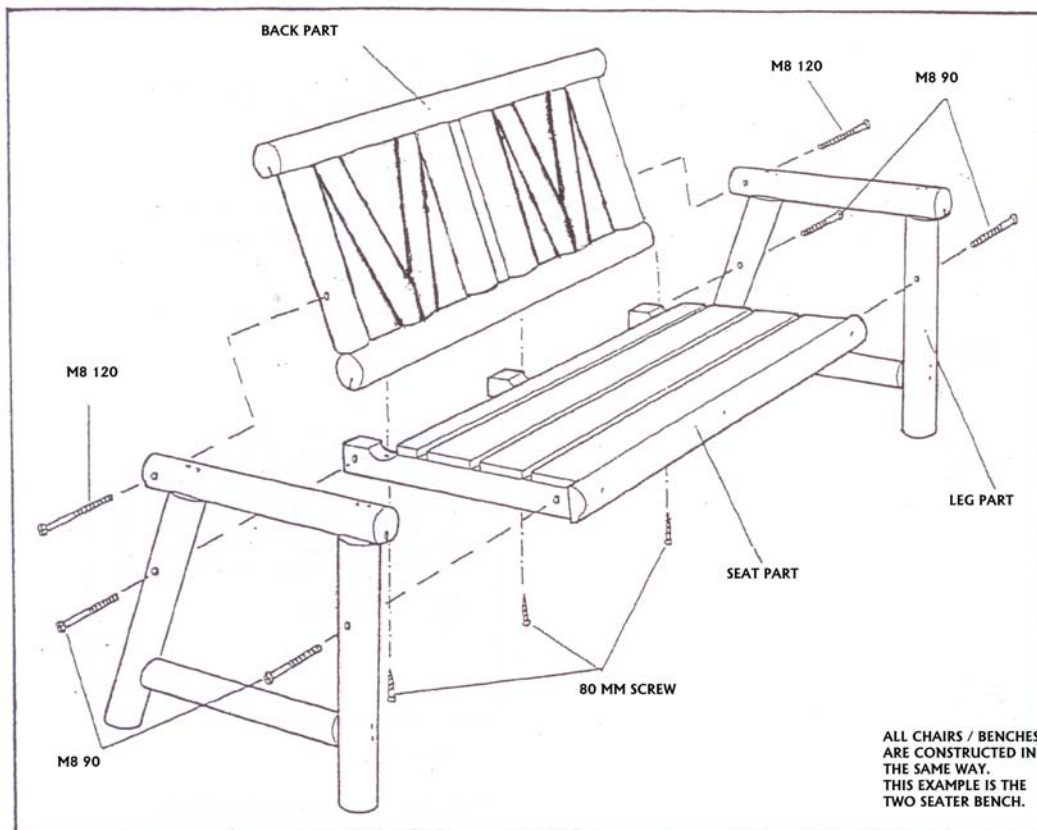

INFORMATION ABOUT YOUR RUSTIC FURNITURE:

Gough's Garden Architecture rustic furniture range offers a two seater bench, a three seater bench, two chairs and a connecting table.

Your furniture is made of FSC certified wood. The timber has been impregnated to protect your furniture against rot, mould, as well as insects (larva). The timber is kiln dried, manufactured, part assembled and treated to category 3 using Korasit® TS. Wood is a natural organic material. Its moisture content fluctuates with the changing season, e.g. high moisture (winter) = expansions, low moisture (summer) = contraction. Therefore cracks may appear in the summer months. This will not affect the strength and durability of your furniture.

MAINTENANCE:

It is recommended to regularly sweep dust and remove any stains. The furniture can be cleaned using soapy water and a soft brush. Allow the timber to dry before applying any preservative.

It is strongly advised to repaint your rustic furniture annually with a wood preservative.

COMPONENTS LIST:

- ❑ Three seater bench: 1 x seat part, 1 x back part, 2 x leg parts, 2 x M8 120mm bolts, 4 x M8 90 mm bolts, 4 x 80 mm screw, 1 x Alley key.
- ❑ Two seater bench: 1 x seat part, 1 x back part, 2 x leg parts, 2 x M8 120mm bolts, 4 x M8 90 mm bolts, 3 x 80 mm screw, 1 x Alley key.
- ❑ Armchair: 1 x seat part, 1 x back part, 2 x leg parts, 2 x M8 120mm bolts, 4 x M8 90 mm bolts, 2 x 80 mm screw, 1 x Allen key.

STEP I

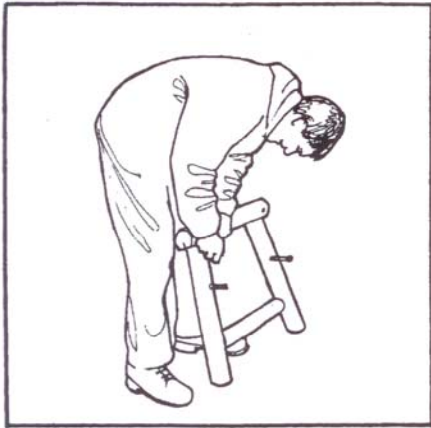

Place M8 90 bolts through leg holes.

STEP II

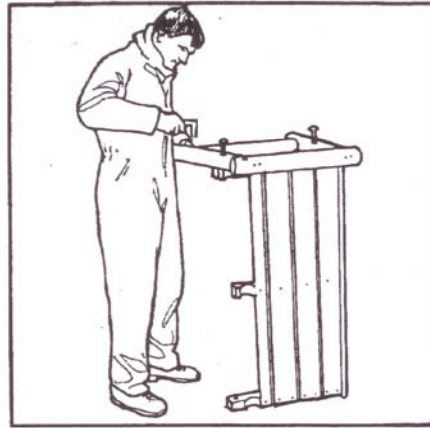

Place the leg part on seat part and gently tap through (being careful not to tap out the nut).

STEP III

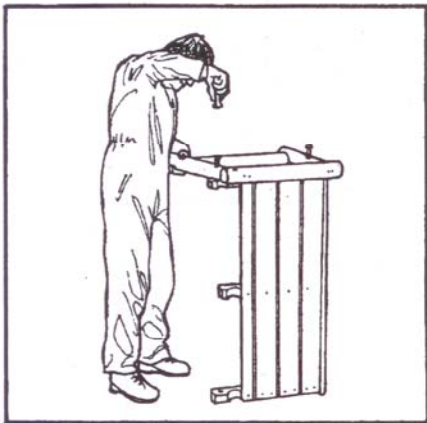

Use the Allen key to tighten bolts and repeat other side.

STEP IV

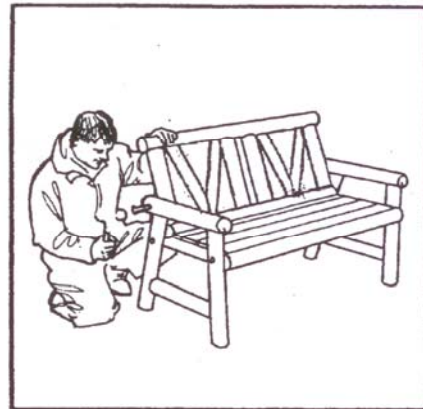

Place seat back in place, line up holes and gently tap M8 120 bolts through being careful not to tap out the nut.

STEP V

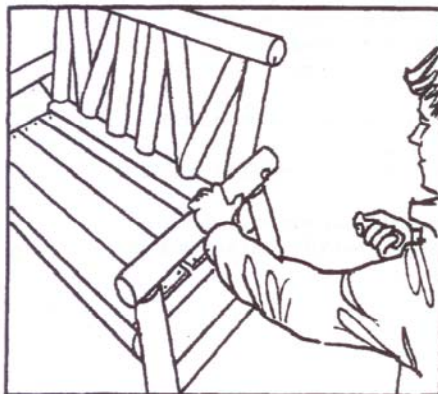

Tighten bolts with Allen key.

STEP VI

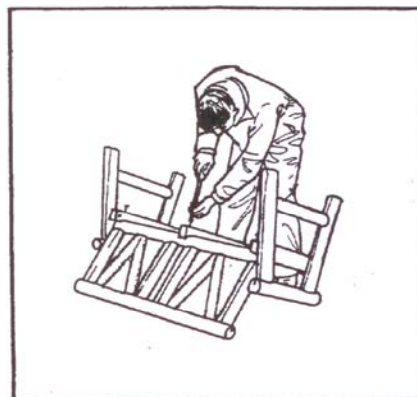

Screw 80 mm screws through seat part into back part. Congratulations! The assembly process is now complete. Please retain the instructions for future reference.